

Gen4 DM Series User Manual

Product models	Description
DM-R/W	All-in-one Constant Current MPPT Charge Controller (-R: infrared remote control; -W: wireless remote control)
DM-UL	With IoT remote control (built-in Lorawan module)
DM-NB	With IoT remote control (built-in NB-IOT module)
DM-GP	With IoT remote control (built-in GPRS module)
DM-BT	With Bluetooth remote control (built-in Bluetooth module)
DM-C	With IoT remote control (RS485 interface, external communication module is required)
DM-CT	With IoT remote control (TTL interface, external communication module is required)

Version: V1.04
Subject to change without notice

1. Overview

The DM series waterproof all-in-one constant current MPPT charge controller integrates MPPT solar charge management, LED step-up constant current drive, IoT remote communication and other functions. Ideal for lead-acid battery / lithium battery / colloidal battery, it is widely used for solar street lights, solar garden lights, etc., providing high reliability, high efficiency, high precision, ease of installation and maintenance and other benefits.

Features

- Using MovingTrack MPPT maximum power tracking technology, higher tracking efficiency and faster speed
- Both lead-acid battery and lithium battery are applicable, operating parameters can be set by remote control;
- Using UltraGreen power control technology with extremely low power consumption and sleep current
- Lead-acid battery multi-stage constant voltage charging with temperature compensation;
- 10-period programmable load power/time control;
- Battery charge and discharge high and low temperature protection, with operating temperature settable;
- A variety of intelligent power modes are available for choice, with load power adjustable automatically according to the battery level;
- High precision digital step-up constant current control algorithm, ensuring high efficiency and high constant current accuracy;
- Infrared wireless communication, allowing for setting/reading parameters, reading status, etc;
- Multiple protections such as battery/PV reverse polarity protection, LED short-circuit/open-circuit/limited power protection, etc;
- Extensible to IoT remote communication monitoring function;
- Full aluminum housing, IP67 waterproof rating, applicable to a variety of harsh environments.

2. Instructions for Use

2.1 MPPT charge introduction:

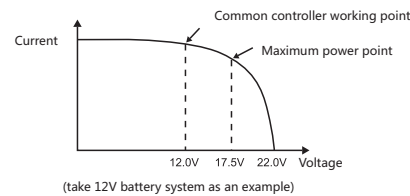

Maximum Power Point Tracking (MPPT for short) is an advanced charging technology. The MPPT controller can detect the generation power of the solar panel in real time and track the maximum voltage and current value (V), allowing the system to charge the battery at the maximum efficiency. Compared with traditional PWM controller, the MPPT controller can maximize the power of the solar panel, so that it can provide a larger charging current. Generally, the MPPT controller can increase the energy utilization by 15% to 20% compared with the PWM controller. As a stage of charging, MPPT cannot be used alone. It is usually necessary to combine the boost charge, floating charge, equalizing charge and other charging modes to complete the battery charging process. The complete charging process for a lead acid battery includes: Quick charge, holding charge and floating charge. The lithium battery charging process does not include equalizing charge and floating charge.

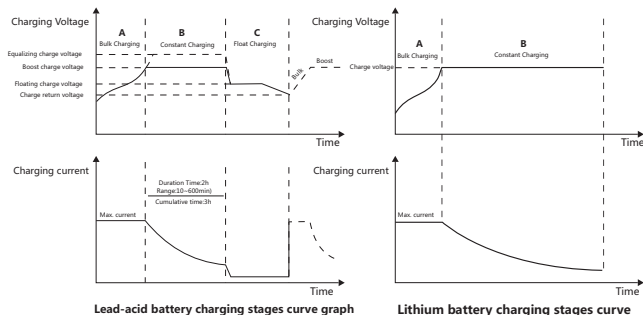

➤ Bulk Charging

In bulk charge stage, the battery voltage has not yet reached the set value of full charge voltage (i.e. equalizing/boost charge voltage) and the controller will perform MPPT charging, which will provide maximum solar energy to charge the battery. When the battery voltage reaches the pre-set value, charge at constant voltage will start.

➤ Constant Charging

When the battery voltage reaches the set value of constant voltage, the controller will perform constant voltage charging. This process will no longer include MPPT charging, and the charging current will gradually decrease with time. Constant charge includes two stages, i.e. equalizing charge and boost charge. The two stages are conducted without repetition, in which equalizing charge is started once every 30 days.

◆ Boost charge

The default duration of boost charge is 2 hours. The customer can also adjust the holding time and the pre-set value of boost voltage point according to actual needs. When the duration reaches the set value, the system will switch to floating charge.

◆ Equalizing charge

Certain types of battery benefit from regular equalizing charge, which can stir electrolyte, balance battery voltage, and complete chemical reaction. Equalizing charge increases the battery voltage above standard voltage, causing vaporization of battery electrolyte. If it is detected that the controller automatically controls the next stage to be equalizing charge, the equalizing charge will last for 120 minutes (default). The equalizing charge and boost charge are not repeated in a full charge process to avoid too much gas evolution or battery overheating.

➤ Floating charge

Floating charge is conducted following the holding charge stage, where the controller will reduce the battery voltage by reducing charge current and allow the battery voltage to remain at the floating charge set value. During the floating charge stage, the battery is charged in a very low voltage to maintain full charge state of the battery. In this stage, the load can get nearly all of the solar energy. If the load exceeds the energy that solar panel can provide, the controller will not be able to maintain the battery voltage in the floating charge stage. When the battery voltage is as low as the recovery charge set point, the system will exit floating charge stage and re-enter the fast charge stage.

2.2 Sleep and wake up:

Enter sleep mode:
Press the [OFF] button on the CU remote control or mini remote control. The controller turns off all external control devices, and enters sleep state with very low power consumption to avoid lithium battery feed due to long time no use;
Wake up from sleep mode:
In sleep mode, press the [ON] button on the CU remote control or mini remote control to wake up the controller and resume normal operation;

2. PV wake up:

A. If [Yes] is selected for the [PV wake up] function, after the controller enters sleep mode, the PV panel connected can wake it up and conduct charging during the day with good conditions for charging. If charging time is more than 1 minutes, the load will be automatically turned on at night; if charging time is less than 1 minutes, the loads will not be turned on at night and the controller will continue to sleep;
B. If [No] is selected for the [PV wake up] function, after the controller enters sleep mode, the PV panel connected can wake it up and conduct charging during the day with good conditions for charging, while the controller will continue to enter sleep mode at night.
(Note: [PV Wakeup] function can be selected by CU remote control).

Controller status	Sleep	Wakeup	Charging	Discharging	Status of LED indicators after sleep
CU-ALL5	OFF button	ON button	--	--	All are off
CU-mini2	OFF button	ON button	--	--	All are off
PV wake up [Yes]	--	PV charging for 10 seconds	Can charge normally during the day	Automatically lights up for 10 seconds after wake-up. Test whether the load is normal. It can discharge normally at night.	--
PV wake up [No]	--	PV charging for 10 seconds	Can charge normally during the day	Automatically lights up for 10 seconds after wake-up. Test whether the load is normal. It does not discharge at night and continues to sleep.	--

2.3 Indicator and remote control status:

The DM series controllers have three red indicators
Three red indicators:

Indicator	Status	Description	Remote control system status
PV indicator	Steady on	Solar panel voltage is higher than light control voltage	Idle
	Off	Solar panel voltage is lower than light control voltage	Idle
	Double flash	Fully charged	Fully charged
	Slow flash	In charging	Charging
	Quick flash	BMS protection or BAT overvoltage or PV overvoltage or over temperature (ambient temperature) or power/ current limited charging	E-BMS Battery overvoltage PV panel overvoltage Over temperature Overcurrent
BAT indicator	Steady on	Battery works properly	Idle
	Off	Battery is not connected or lithium battery protection board over discharge protection	
LOAD indicator	Quick flash	Battery over-discharge	Over discharge
	Steady on	Load is turned on	Discharging
	Off	Load is turned off	Idle
	Slow flash	Load is open circuited	Open circuit
	Quick flash	Load is short circuited	Short circuit

2.4 Intelligent power:

The DM series controller is available in various intelligent power modes for selection according to the actual battery capacity, the number of rainy days and other factors. The specific intelligent power modes are: High, Moderate, Low, Auto, USE (user-defined), No (off). Intelligent power levels:
High -The battery capacity at the starting point of power derating is high, and the load lighting time is the longest. It is suitable for use in areas with more rainy days or poor lighting conditions;
Moderate-The battery capacity at the starting point of power derating is moderate, and the load lighting time is moderate. It is suitable for the scenarios where both brightness and the number of rainy days are considered;
Low-The battery capacity at the starting point of power derating is low, and the load lighting time is the shortest. It is suitable for scenarios with high lighting requirements;

Intelligent power curve:

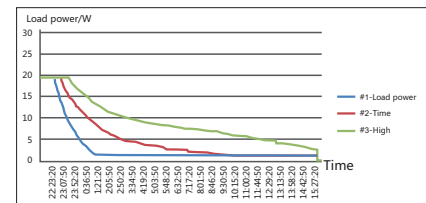

Intelligent power test data

Comparison between intelligent power consumption and that in rainy days		
Intelligent power levels	Power consumption per day	Sustainable operating days
No	100%	1
Low	50%	2
Medium	25%	4
High	15%	6

[Test description: 1. The test battery is fully charged, the maximum load power is consistent, and the operating time is consistent. 2. Assume that the power consumption is 100% when the intelligent power is turned on.
3. The test result is the data obtained under a single condition (the charge level is 0 per day). The actual use may be different from the test conditions, and the test results are for reference only.]

Auto - Intelligent power mode automatically selects high/moderate/low level according to the parameters such as daily charge and power consumption; for example, in summer, the charge level is large, it runs in low power mode, and the lighting effect is better; in winter, the charge level is small, it runs in high power mode, the load works in the power saving mode and can hold in more rainy days.
USE (user-defined)-The user is allowed to set the derating start voltage, the derating end voltage, and the minimum load current value for the intelligent power;

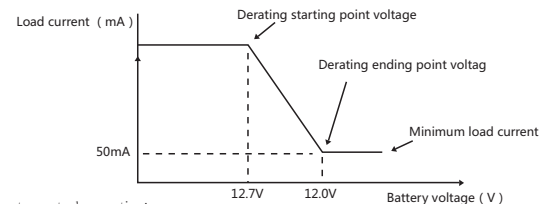

2.5 Remote control operation:

2.5.1. Remote control CU/ALL5:

The communication between the controller and the handheld remote control CU-ALL5 can be controlled by infrared remote control or wireless remote control mode. Press [+] and [-] buttons on the remote control at the same time to select [Remote Control Type] (Infrared/Wireless) for remote operation. In actual use, the infrared remote control signal is easy to attenuate under outdoor strong light, the remote communication distance is 5-6m; while at night, the remote communication distance is 8-10m; the wireless remote control signal can penetrate plastic or aluminum housing, and the wireless remote control distance can be adjusted from 0.3m to 20m via the remote control.

Specific [Parameter settings] and [operation status] of the remote control are as follows:

Parameter settings:

Items	Default	Range
Battery type	Lead	Lead / lithium 12V / lithium 24V
Sensing delay	No	No
PV wake up	Yes	No/Yes
Light control voltage	5V	3V-11V
Light control delay	10s	5s-60min
Over discharge voltage	11.0V	9.00V-17.0V
Over discharge return voltage	12.6V	9.00V-17.0V
Boost charge	14.4V	9.00V-17.0V
Floating charge	13.8V	9.00V-17.0V
Low temperature charge	-35°C	-35°C-0°C
High temperature charge	65°C	40°C-90°C
Load current	0.33A	0.15A-7.0A
Intelligent power	Moderate	No/High/Moderate/Low/Auto/**USE
*Derating start voltage	12.4V	9.00V-17.0V
*Derating end voltage	11.4V	9.00V-17.0V
*Minimum current	0.15A	0.05A-1.00A
Load parameter settings	Nth time	00:00-15:00
	Power with no human motion sensed	0%-100%
	Power with human motion sensed	0%-100%
Factory reset	No	No/Yes

Default load parameter settings:

Time period	Hrs/Min	Power in the period
1	00:30	50%
2	00:30	70%
3	02:00	100%
4	00:30	70%
5	00:30	50%
6	04:00	30%
7	00:00	0%
8		
9		
Pre-dawn lighting time		

Status data:

Press the [Status] button on the remote control at any interface to read the [Run Status] data of the controller;
Press and hold the [Status] button on the remote control at any interface to enter the [Status Data] submenu, where you can choose to read [Run Status] / [Historical Data], that is, select [Run Status] or [Historical Data] and press the [Status] button to read the corresponding status data.

Name	Example	Description
System status	Discharging	Current run status: discharge / charge / idle / full / over discharge, etc.
Battery voltage	12.3V	Current voltage of the battery
PV voltage	17.6V	Current solar panel voltage
Charge current	0.0A	Current charge current
Charge power	0.0W	Current charge power
Charge AH	0.01AH	Charge AH of the day
Load voltage	27.1V	Current load voltage
Load current	1.00A	Current load current
Load power	27.2W	Current load power
Lighting time	05:20	Total length of actual lighting time of a night
Sensing time	01:10	Length of actual lighting time of a night with human motion sensed
Discharge AH	2.05AH	Discharge AH of a night
Ambient temperature	23°C	Current internal temperature
Running days	15D	Accumulated running days
Number of over discharge	2N	Total number of over discharge of lithium battery
Number of full charge	10N	Total number of full charge of lithium battery
Production date	1810	Production date of controller
Software version	1000	Software version of controller

Historical data:
The historical running data of the controller in the last 30 days can be read by the remote controller, and the number of days to read can be selected.

Status name	Example	Description
-----Past N days-----		The number of days can be selected, N=0-30
Minimum voltage	11.2V	Minimum voltage of the battery in the past N days
Maximum voltage	14.2V	Maximum voltage of the battery in the past N days
Maximum temperature	38°C	Maximum ambient temperature in the past N days
Minimum temperature	23°C	Minimum ambient temperature in the past N days
Charge power	205W	Maximum charge power in the past N days
Lighting time	07:10	Lighting time at night in the past N days
Charge AH	55AH	Total charge AH in the past N days
Charge AH	49AH	Total discharge AH in the past N days
Charge WH	408WH	Total charge WH in the past N days
Discharge WH	350WH	Total discharge WH in the past N days

2.5.2 Remote control CU-mini2: (optional)
The mini type remote control CU-mini2 is used for turning on/off and testing.

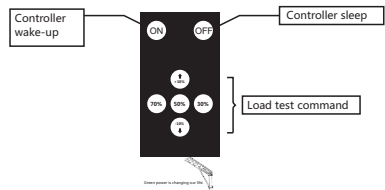

A total of 7 buttons are available: [ON], [OFF], [70%], [50%], [30%], [+10%], [-10%], button icons and descriptions are as follows:

2.6 Installation method:

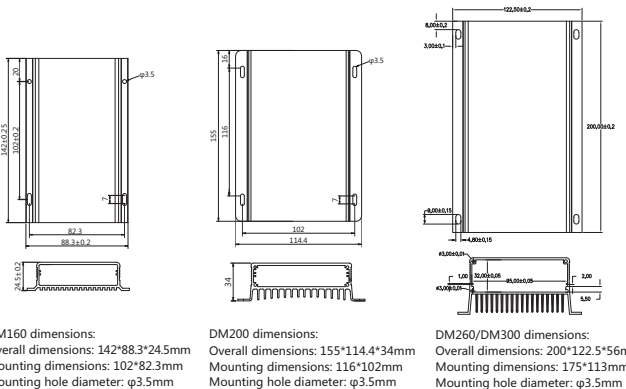
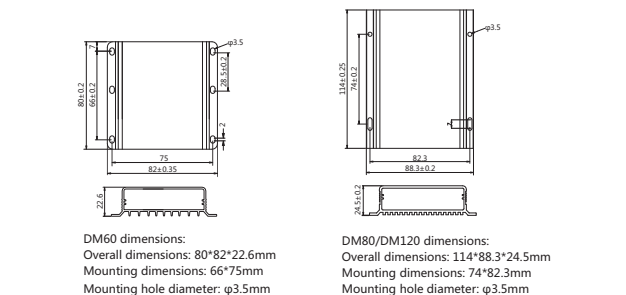

3. Technical parameters

Items	Values						Adjustable	Default
	DM60	DM80	DM120	DM160	DM200	DM260		
Model	DM60	DM80	DM120	DM160	DM200	DM260	DM300	
Controller type	-R: infrared remote control; -W: 2.4G wireless remote control; -C: with 485 communication interface							
System voltage	12V			12V/24V				Lead-acid
Static power consumption	-R: ≤5mA -W: ≤20mA	-R: ≤6mA -W: ≤20mA	-R: ≤6mA/12V; 4mA/24V -W: 18mA/12V; 13mA/24V	-R: 8mA/12V; 12mA/24V -W: 20mA/12V; 16mA/24V				
Sleep power consumption	≤1mA			≤2mA				
Load current	50~3000mA		50~4200mA	50~5600mA		70~7000mA		√ 330mA
Load voltage	15V~50V		15V~40V	15V~60V		15V~75V		
Maximum load power	60W/12V	80W/12V	60W/12V 120W/24V	80W/12V 160W/24V	100W/12V 200W/24V	130W/12V 260W/24V	150W/12V 300W/24V	
Load conversion efficiency	85%-96% (Typical efficiency 95%)							
Load current accuracy	≤3%±30mA							
Intelligent power	High, Moderate, Low, Auto, USE, No						√	Medium
Load working period	9-Period + Pre-dawn lighting							
Period adjustment range	1min / 10min							
Power adjustment range	1% / 10%							
Maximum solar input power	130W/12V	200W/12V	130W/12V 260W/24V	200W/12V 400W/24V	260W/12V 520W/24V	400W/12V 800W/24V	550W/12V 1100W/24V	
Maximum charge current	10A	15A	10A	15A	20A	30A	40A	
Maximum solar input voltage	≤50V	≤35V	≤60V		≤100V			
MPPT Tracking efficiency	> 99%							
Charging conversion eff.	85%-98% (Typical efficiency 97%)							
Over voltage	PB-16.0V; LI-overcharge voltage +2V; × 2, 24V system						√	16.0V
Limited charge voltage	PB-15.5V; LI-overcharge voltage +1V; × 2, 24V system							15.5V
Equalizing charge voltage	PB-14.6V; LI-None; × 2,24V system							14.6V
Equalizing charge interval	PB: 30 days ; LI: no ;							30D
Boost charge voltage (lead-acid)								14.4V
Charge voltage (lithium)	8.5V ~ 17.0V ; × 2,24V system						√	14.4V
Floating charge voltage (lead-acid)	8.5V ~ 17.0V ; × 2,24V system						√	13.8V
Charge return voltage (lithium)								
Over discharge voltage	8.5V ~ 17.0V ; × 2,24V system						√	11.0V
Over discharge return voltage	8.5V ~ 17.0V ; × 2,24V system						√	12.5V
Temperature compensation coefficient	PB: -3.0mV/°C/2V; lithium battery: no compensation							
Light control voltage	3V ~ 11V ; × 2,24V system						√	5V
Light control delay	0s ~ 60s/2min ~ 60min						√	10s
High temperature charge	+40°C ~ +90°C						√	65°C
Low temperature charge	0°C ~ -35°C						√	-35°C
Operating temperature	-35°C ~ +65°C							
IP rating	IP67							
Protections	Battery reverse polarity protection, solar panel reverse polarity protection, solar panel over-voltage protection, lithium battery overcharge and over-discharge protection, lithium battery BMS overcharge detection protection, over temperature protection, load open circuit and short circuit protection,							
Weight	260g	400g	510g	770g	1800g			
Controller dimensions (mm)	80*82*22.6	114*88.3*24.5	142*88.3*24.5	155*114.4*34	200*122.5*56			
Controller mounting dimensions (mm)	66*75	74*82.3	102*82.3	116*102	175*113			
Mounting hole diameter (mm)	φ3.5							

4. Protections

- **Water ingress protection**
IP rating: IP67
- **Lithium battery BMS overcharge protection**
When the controller detects that the BMS is overcharged, the controller stops charging immediately, preventing the high voltage of the photovoltaic terminal from being applied to both ends of the BMS for a long time, causing the BMS to be damaged by high voltage.
- **Lithium battery low temperature charging protection**
When ambient temperature drops to the set value, the controller stops charging to prevent irreversible damage to the lithium battery due to low temperature charging. When ambient temperature is higher than the set value, the controller stops charging and discharging to prevent damage to the lithium battery from due to excessive temperature.
- **Battery reverse polarity protection**
As the battery polarity is reversed, the system does not work and will not burn the controller.
- **PV input terminal overvoltage protection**
When the voltage at the PV panel input terminal is too high, the controller will automatically cut o the PV input.
- **PV input terminal short circuit protection**
As the input terminal of the PV array is short-circuited, the controller stops charging. When the short-circuit condition is cleared, charging will automatically resume.
- **PV input reverse polarity protection**
When the polarity of the PV array is reversed, the controller will not be damaged. After correcting the wiring error, it will continue to work properly.
- **Load power limit protection**
When the power of LEDs that the customer uses is too large, or the load current is adjusted to be excessive, the controller will limit the load power output to less than the rated power, to ensure that the controller and LED load will not be damaged.
- **Load overload and short circuit protection**
When the number of LEDs connected in series in the load is too low (3 strings or less), the controller will stop output immediately to prevent damage to LED load or controller; When a short circuit occurs, the controller immediately cuts o the load output to prevent damage to the controller. After the load short-circuit condition is released, the controller automatically resumes output within 1 minute (if it has been short-circuited for a long time, it will automatically resume output once every 1 hour), or press and hold the test button on the remote control (CU or mini2) for 10s to automatically resume output.
- **Load open circuit protection**
When the load wiring is suddenly disconnected as LED is normal on, the controller can immediately turn o load output to protect the controller from damage. After the load wiring is reconnected, the controller automatically resumes output within 10 minutes (if it has been open-circuited for a long time, it will automatically resume output once every 1 hour), or press and hold the test button on the remote control (CU or mini2) for 10s to automatically resume output.
- **Night reverse-current protection**
At night, the battery is prevented from discharging through the PV panel.
- **TVS lightning protection.**

5. Electrical wiring diagrams

A. Wiring diagram of the controller with built-in IoT module

Wiring sequence: Firstly connect the load, then the battery and finally the solar panel.

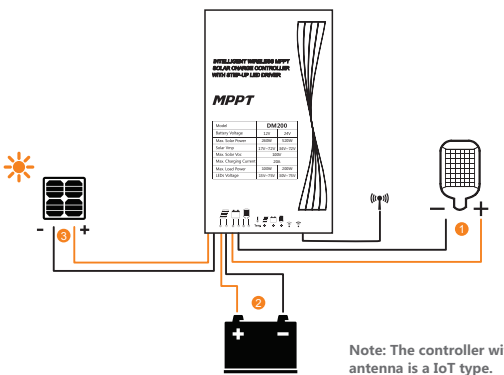

Note: The controller with antenna is a IoT type.

B. Wiring diagram of the controller with external IoT module

Wiring sequence: Firstly connect the external IoT module, then the load, then the battery and finally the solar panel.

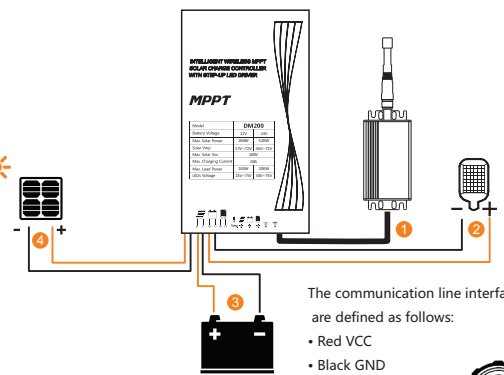

The communication line interfaces are defined as follows:

- Red VCC
- Black GND
- Yellow A/T
- White B/R

6. Common abnormalities and Solutions

No.	Exceptions	Causes	Solutions
1	Remote control cannot work	A. The remote control password is incorrect B. Remote control mode (infrared or wireless) is not selected correctly C. Wireless remote control distance setting is too short D. The remote control battery is low	B1. Press the "+" and "-" keys at the same time to bring up the [Remote Control Settings] interface and set the correct password. B2. Press the "+" and "-" keys at the same time to bring up the [Remote Control Settings] interface, and then select [Infrared Remote Control] or [Wireless Remote Control]. C1. Press the "+" and "-" keys at the same time to bring up the [Remote Control Settings] interface, and then increase the [Remote Distance] before testing. D1. Please replace 2 AA (No. 5) batteries
2	There is no response when the controller is connected to battery and the remote control has no response.	A. Battery is problematic in power supply B. Controller goes to sleep mode	A1. Check if the battery wiring is intact A2. Check if there is voltage on the battery terminal and whether the protection board is activated. If there is no voltage on the battery terminal, it indicates that the protection board has provided protection, and the battery can be charged to be activated. B1. Press the "ON" button on the remote control to activate the controller. B2. Connect the solar board to charge the battery.
3	Charge is normal during the day, but the load does not light up at night, and the LED indicator on the controller does not light up either	A. Controller is in sleep state	A1. Press the "ON" button on the remote control to activate the controller A2. Select <PV Wakeup> to "Yes", and the controller will be activated automatically after
4	The battery indicator flashes quickly, and the load LED does not light up	A. Battery is low	A1. Turn "Intelligent power" off and test load current B1. Set the current to be smaller or replace the lamp with fewer LEDs in series.
5	Load lighting time is short	A. Battery is low B. Load power is excessive	A1. Check if the solar panel is charging normally and if the solar panel configuration is correct. A2. Check if the lithium battery has a single-cell protection. B1. Check if the controller current setting is correct and if the load power is normal.
6	Load lighting current does not reach the set value	A. Load current is regulated in intelligent power mode B. LED power exceeds the rated value	A1. Turn "Intelligent power" off and test load current B1. Set the current to be smaller or replace the lamp with fewer LEDs in series.
7	The load indicator flashes and the load LED does not light up	A. LED is open circuited B. LED load wiring is shorted or the number of LEDs in series is too few	A1. Please check if the load wiring is correct, and if the LED polarity is reversed. B1. Please check if the load wiring is shorted, and if the LED polarity is reversed. B2. Please check if the LED string is correct, and replace the light appropriate number of LEDs in series or parallel.
8	LED load dimming fails	A. The number of LEDs in series is incorrect, 3 LEDs or step-down LEDs are used	A1. Replace with step-up LEDs (5 or more strings)
9	Lighting during the day	A. Solar panel is not connected B. Solar panel polarity is reversed	A1. Check if the battery board is connected correctly and if the wiring is reliable. B1. Reverse the solar panel wiring during the day to see if the charging indicator flashes.
10	The charge indicator does not flash slowly when there is sunlight during the day.	A. Solar panel failure or solar panel wiring error	A1. Check if the solar panel connection is correct and reliable, and if the solar panel is blocked.
11	LED load does not light up, battery indicator is steady on.	A. The solar panel voltage is not lower than the light control voltage or the delay time has not been up yet. B. The controller time runs up	A1. LED load automatically lights up after the solar panel voltage drops B1. When controller recharges, reset timer
12	Charge indicator flashes quickly, no charging current	A. Lithium battery BMS protection board overcharge protection.	A1. Charging is automatically resumed after the lithium battery voltage drops to the overcharge return.